

The **rail-mounted switch SW-1CHL** (1 channel) is a cutting-edge product of the **MASTER Smart Home** line, suitable for controlling and managing (on-off) your lighting and electrical appliances. Automate, control and inspect the state of your appliances while reducing your household costs, with the ability to operate locally via buttons and remotely via internet or Wi-Fi using smartphone, tablet or PC.

This user manual will help you install the **MASTER Smart Home** app for Android or iOS and enjoy the “smart” lighting control functions.

Advantages

- Visualization, control and management of lighting and electrical appliances (on-off)
- User-friendly, easy-to-use interface
- Works with the Google Assistant voice commands
- Secure connection to Wi-Fi
- No hub/gateway is required
- Timer function
- Time-schedules
- Maximum economy and comfort with smart scenes
- Low implementation cost in existing or new installations

Technical Specifications

RAIL MOUNTED SWITCH (1 MODULE)	1 CHANNEL (RELAY)
SAFE OPERATING VOLTAGE	180 - 230 VAC
SAFE OPERATING FREQUENCY	50Hz
OUTPUT POWER	1840W / 8A max
OUTPUT POWER BOOST	The output power of the product can be extended by adding the corresponding power relay according of the electric load
STAND BY CONSUMPTION	≤ 1W
OPERATION TEMPERATURE	-20°C to +50°C
WIRE SIZE	∅0,5mm to ∅ 3,5mm
MOUNTING	Din-rail mounting 35 x 7,5 mm (DIN 45277)
CONTROL	<u>Local:</u> - Instant push of product button - With one or more parallel connected buttons <u>Remote:</u> With the MASTER Smart Home app for smartphones or tablets over Wi-Fi or Data

MASTER
Smart Home
RAIL-MOUNTED SWITCH
(1 CHANNEL)
SW-1CHL



Works with Google Assistant voice commands



Electric Loads

R	L	C / L			
RESISTIVE	INDUCTIVE	CAPACITIVE / INDUCTIVE			
			Economy	LED	Filament
1840W max	1840VA max	1840VA max	1840W max	1840W max	1840W max
1W min	1VA min	1VA min	1W min	1W min	1W min



This product complies with the requirements of the following EU Directives: 2014/30/EE (EMC), 2014/35/EE (LVD)

This product should be disposed of in accordance with national laws and environmental protection requirements

Draft of Electrical Installation

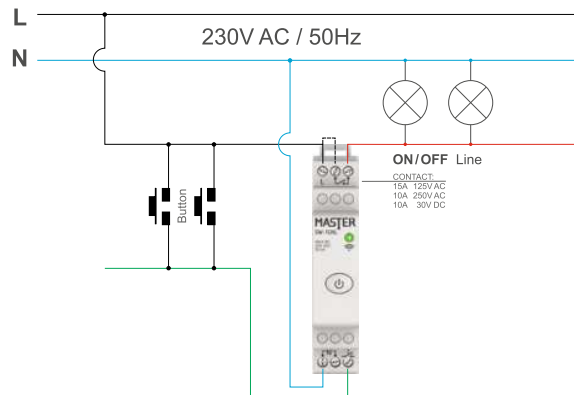

Create a User Account

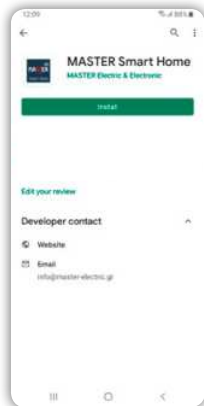

Step 1



Step 2



Step 3

Download the «MASTER Smart Home» free app and create an account.

Step 1

Download the “MASTER Smart Home” application from Google Play or the App Store.

Step 2

Launch the application and tap “SIGN UP”.

Step 3

Enter your credentials, tap “OK” and follow the instructions in the activation email you received.

Create a Location

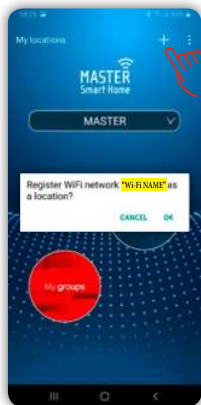

Step 4

Create easily and quickly different locations for the office or home.

* First, make sure your Smartphone or Tablet is connected to your local Wi-Fi network.

Step 4

Sign in to the “MASTER Smart Home” application and press “+” to create your location.

* The name of the location that originally appears, is the name of your wireless local Wi-Fi network.

New Device Connection

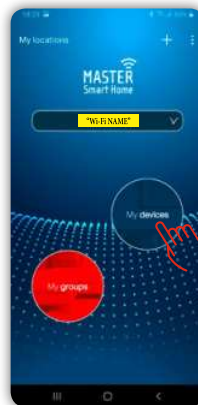

Step 5

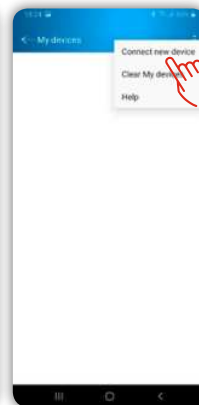

Step 6

Easily and quickly connect your smart device to your local Wi-Fi network.

Step 5

From the app homepage, select “My Devices”.

Step 6

Press “⋮” and select “Connect a new device” from the popup window.

New Device Connection

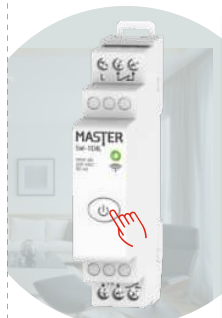

Press the control button on the SW-ICHL, 10 times repeatedly

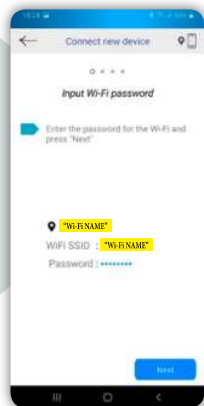

Step 7

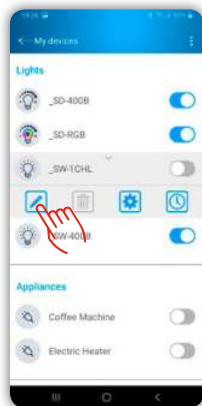

Step 8

Step 7

Press 10 times repeatedly the control button on the SW-ICHL rail-mounted switch and follow the instructions in the «MASTER Smart Home» application.

* The “SSID” field automatically displays the name of your Wi-Fi network.

Step 8

After its successful connection, the SW-ICHL rail-mounted switch appears in «My devices». Select the connected switch to operate or configure it.